

Model No.VR003C CORDLESS CONCRETE VIBRATOR

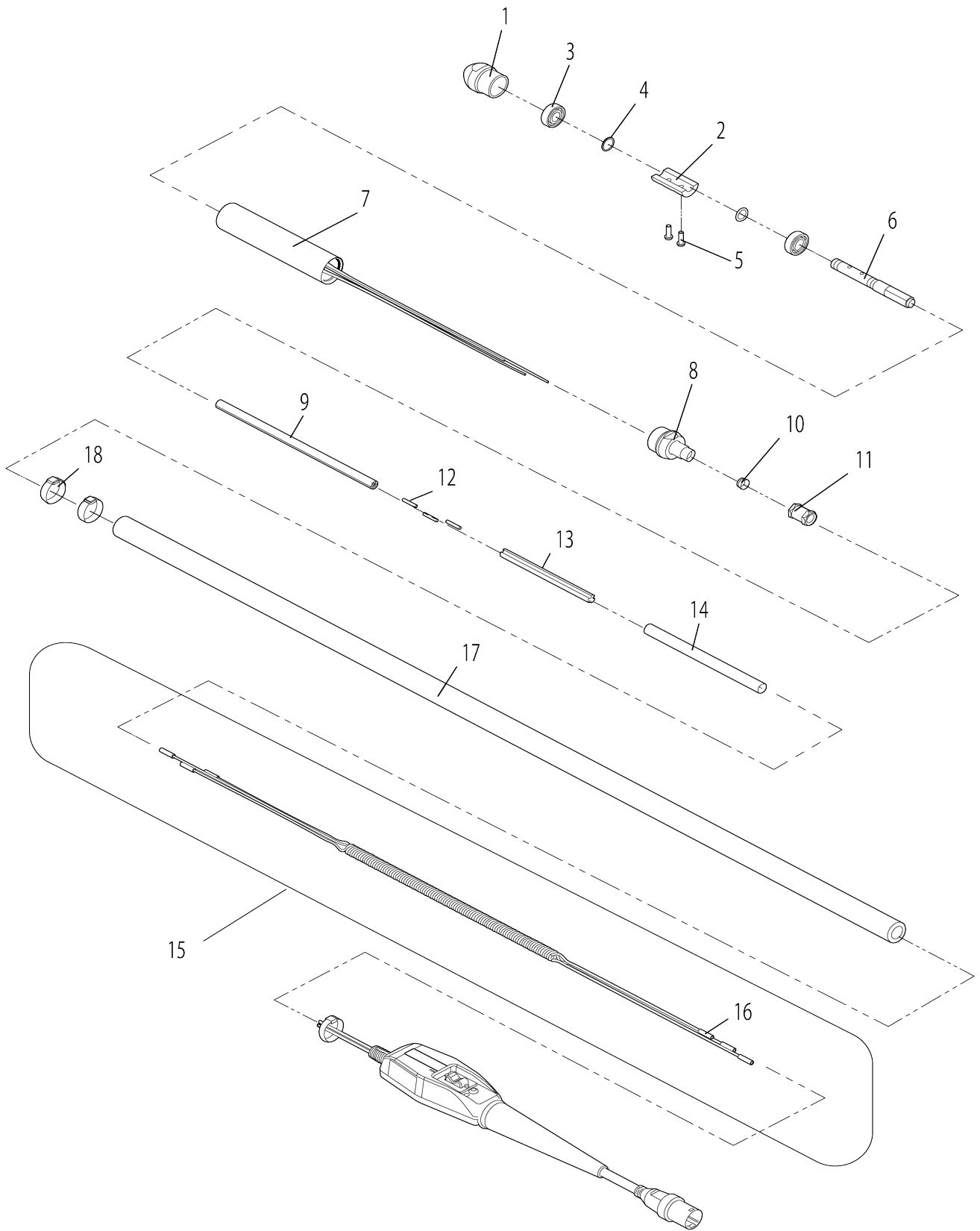

Model No.VR003C CORDLESS CONCRETE VIBRATOR

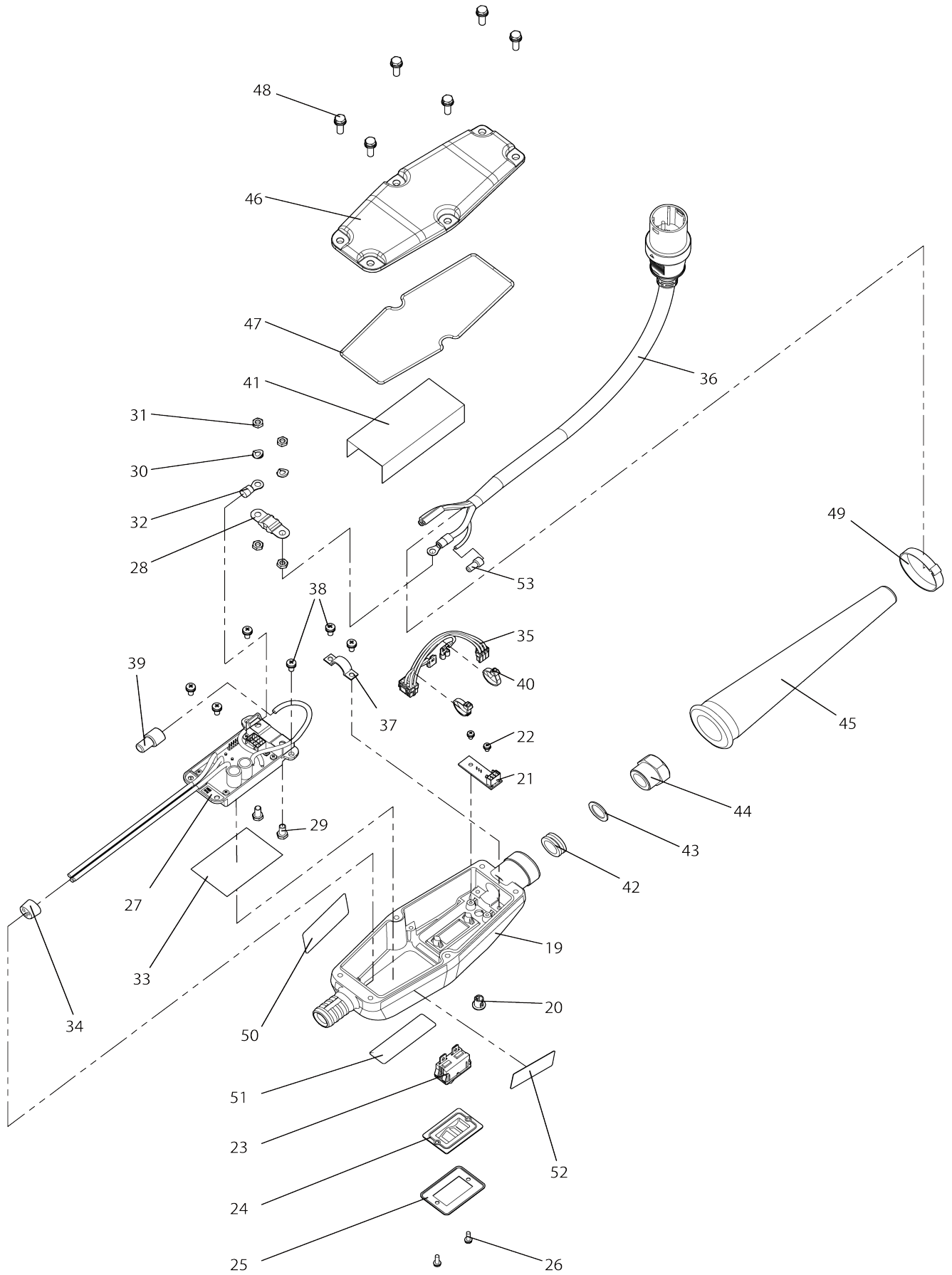

Model No.VR003C CORDLESS CONCRETE VIBRATOR

Numéro d'article	N ° de pièces	Description	Interchangeabilité	Q'ty	Nouvelle / ancienne	Note 1	Note 2
001	HA00000364	VIBRATOR CAP		1			
002	HA00000365	ECCENTRIC WEIGHT		1			
003	HA00000366	BEARING 6302JR2LLHC3		2			
004	HA00000313	WASHER M15.5X22		2			
005	HA00000367	H.S.H. BUTTON BOLT M6X25		2			
006	HA00000368	ROTOR		1			
007	HA00000369	MOTOR ASSEMBLY		1			
008	HA00000370	HOSE JOINT		1			
009	HA00000318	TUBE R6.5X3.5-300		3			
010	HA00000319	RUBBER RING M13X17		1			
011	HA00000320	HOSE ADAPTER		1			
012	HA00000321	HEAT-SHRINK TUBING R1/8X30		3			
013	HA00000322	INTERNAL CABLE GUIDE		1			
014	HA00000323	HEAT-SHRINK TUBING 15X220		1			
015	HA00000324	INTERNAL CABLE ASSEMBLY(1.5 M)		1			
D10		INC. 16					
016	HA00000325	BUTT CRIMP CONNECTOR		6			
017	HA00000326	HOSE M20X33X1.5M		1			
018	HA00000327	HOSE CLAMP M38 W10		3			
019	HA00000328	INVERTER CASE		1			
020	HA00000329	LED LENS COVER		1	*		
020-1	HA00000379	LED LENS COVER	S	1			
021	HA00000330	CIRCUIT BOARD LED		1			
022	HA00000331	PAN HEAD SCREW M3X6		2			
023	HA00000332	SWITCH		1			
024	HA00000333	SWITCH COVER		1			
025	HA00000334	SWITCH PLATE		1			
026	HA00000335	PAN HEAD SCREW M3X12		2			
027	HA00000336	CIRCUIT BOARD ASSEMBLY		1			
028	HA00000337	FUSE		1			
029	HA00000338	HEX BOLT M5X12		2			
030	HA00000079	SPRING WASHER 5		2			
031	HA00000339	LOCK NUT M5		4			
032	HA00000340	RING TERMINAL		1			
033	HA00000341	INSULATION SHEET B		1			
034	HA00000342	CABLE STOPPER		1			
035	HA00000343	HARNESS BOARD		1			
036	HA00000344	CABLE ASS'Y		1			
D10		INC. 53					
037	HA00000346	CORD CLAMP		1			
038	HA00000347	PAN HEAD SCREW M4X10		6			
039	HA00000348	CLOSED END CONNECTOR CE-8		1			
040	HA00000349	CABLE TIES		2			
041	HA00000350	INSULATION SHEET		1			
042	HA00000351	RUBBER RING M15X22X16		1			
043	HA00000313	WASHER M15.5X22		1			
044	HA00000352	COMPRESSION NUT M15.5		1			

045	HA00000353	CORD GUARD		1			
046	HA00000354	INVERTER COVER		1			
047	HA00000355	RUBBER SEAL		1	*		
047-1	HA00000378	RUBBER SEAL	O	1			
048	HA00000356	HEX BOLT M5X20		6			
049	HA00000357	CLAMPING RING		1			
050	HA00000358	LABEL WARNING MANUAL		1			
051	HA00000359	LABEL MAKITA		1			
052	HA00000371	LABEL NPE VR003C		1	*		
053	HA00000345	CLOSED END CONNECTOR CE-1		1			
054	HA00000380	LED LENS COVER SEAL		1			
055	HA00000381	SEAL WASHER M3		2			

Veillez indiquer les pièces n ° lorsque votre commande.

Date d'impression 06/07/2024